

Product Detail

Flex-C Trac

6" - 16 Ga.

Isometric View

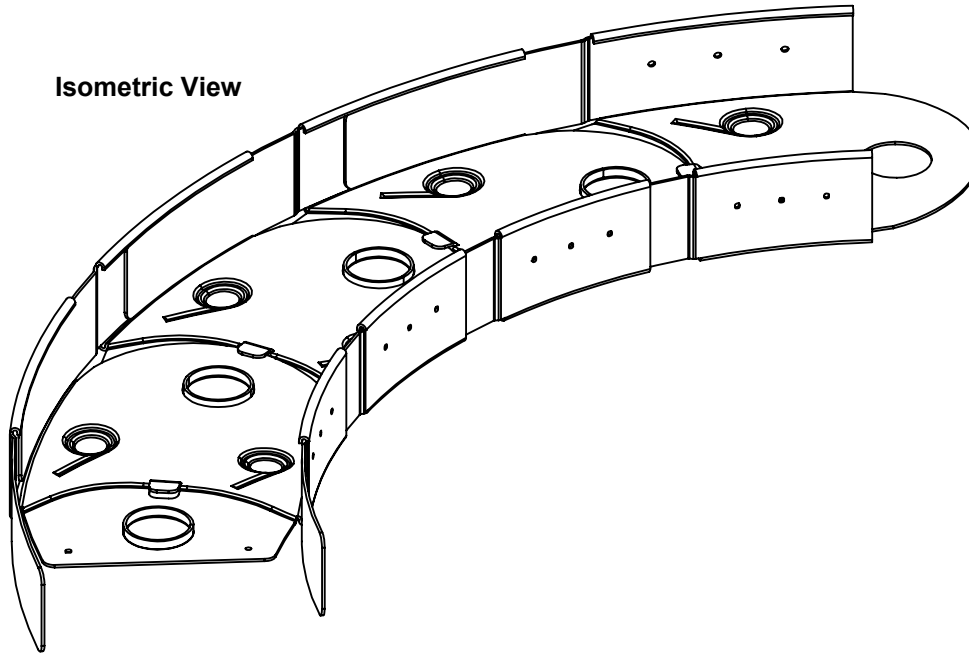

Specifications

Channel:

- ASTM A653, structural grade 50, hot dipped galvanized steel
- Standard protective coating equal or superior to ASTM A653 coating designation G-60 minimum.
- 16 gauge
- Length: 10'

Integral Strap:

- The specifications for the strap are the same as the channel with 16 Ga. thickness.

Sectional View

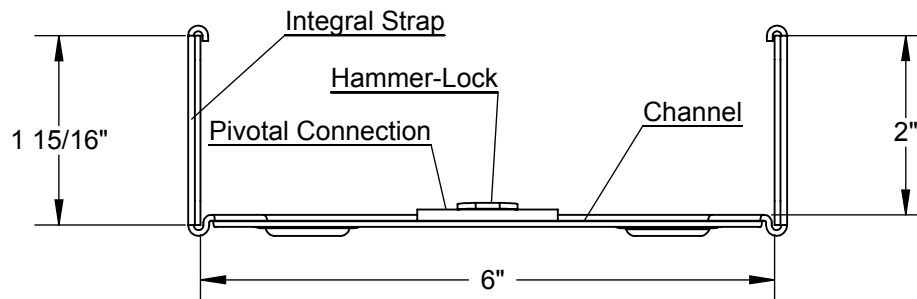

**FLEX-ABILITY
CONCEPTS**

Distributor:
Contractor:
For Product Line PDM
Product Detail: PDM7

Quantity:
Approved By:
Architect:
Date:

5500 W. Reno, Suite 300
Oklahoma City, OK 73127
Tel: 405-996-5343 Fax: 405-996-5353
E-mail: info@flexabilityconcepts.com
Web: www.flexabilityconcepts.com