

# Product Detail

## Flex-C Trac

### 8" - 16 Ga.

Isometric View

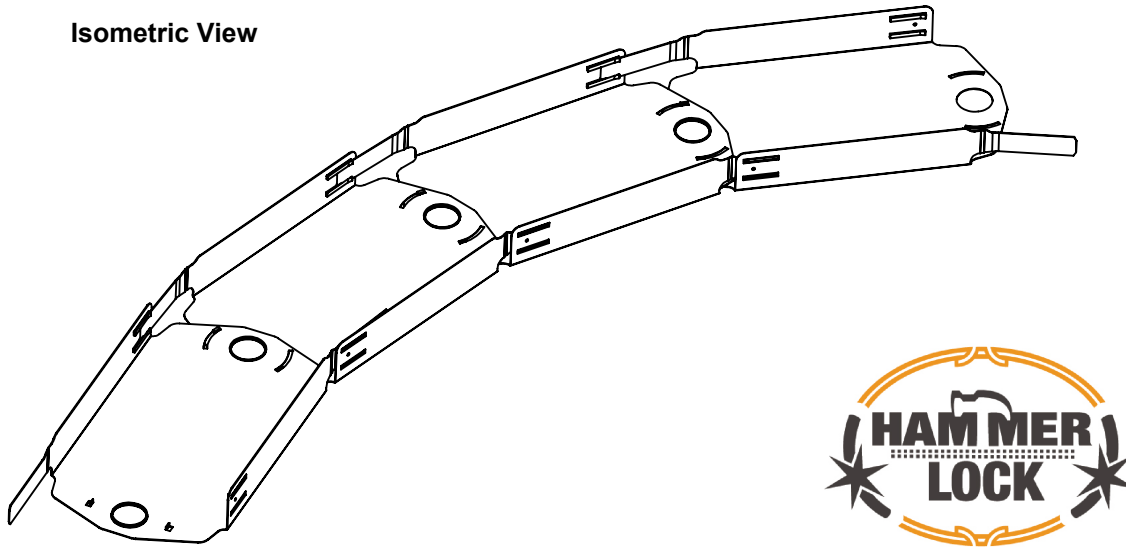

### Specifications

#### Channel:

- ASTM A653, structural grade 50, hot dipped galvanized steel
- Standard protective coating equal or superior to ASTM A653 coating designation G-60.
- 16 gauge
- Length: 10'

#### Integral Strap:

- The specifications for the strap are the same as the channel with 16 Ga. thickness.

Sectional View

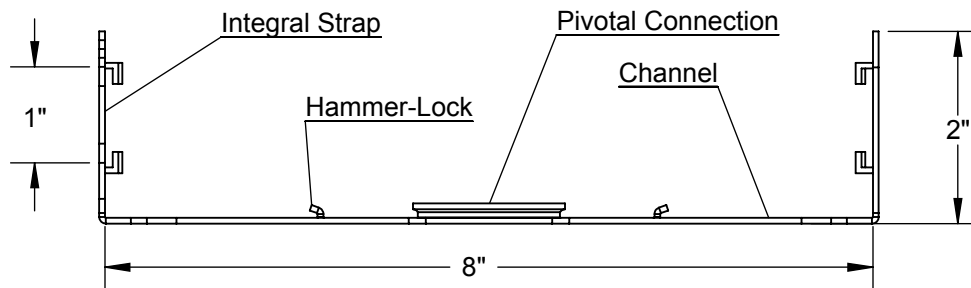

FLEX-ABILITY  
CONCEPTS

Distributor:  
Contractor:  
Project:  
Product Detail: PDM9

Quantity:  
Approved By:  
Architect:  
Date:

5500 W. Reno, Suite 300  
Oklahoma City, OK, 73127  
Tel: 405-996-5343 Fax: 405-996-5353  
E-mail: [info@flexabilityconcepts.com](mailto:info@flexabilityconcepts.com)  
Web: [www.flexabilityconcepts.com](http://www.flexabilityconcepts.com)